

 <small>klimasmart med deg</small>	Tiltakshaver: Overhalla kommune	Uteområde
	Byggeplass: OBUS	Dato: 08.01.2020
	Kommune: Overhalla	Tegn: ags
	Gnr: _____ Bnr: _____ Mål: 1 : 100	Prosjekt: 1814- Uværskur
	Fasader	Tegn.nr: 502

© Tegningen kan ikke brukes uten samtykke fra Ark. Blom as

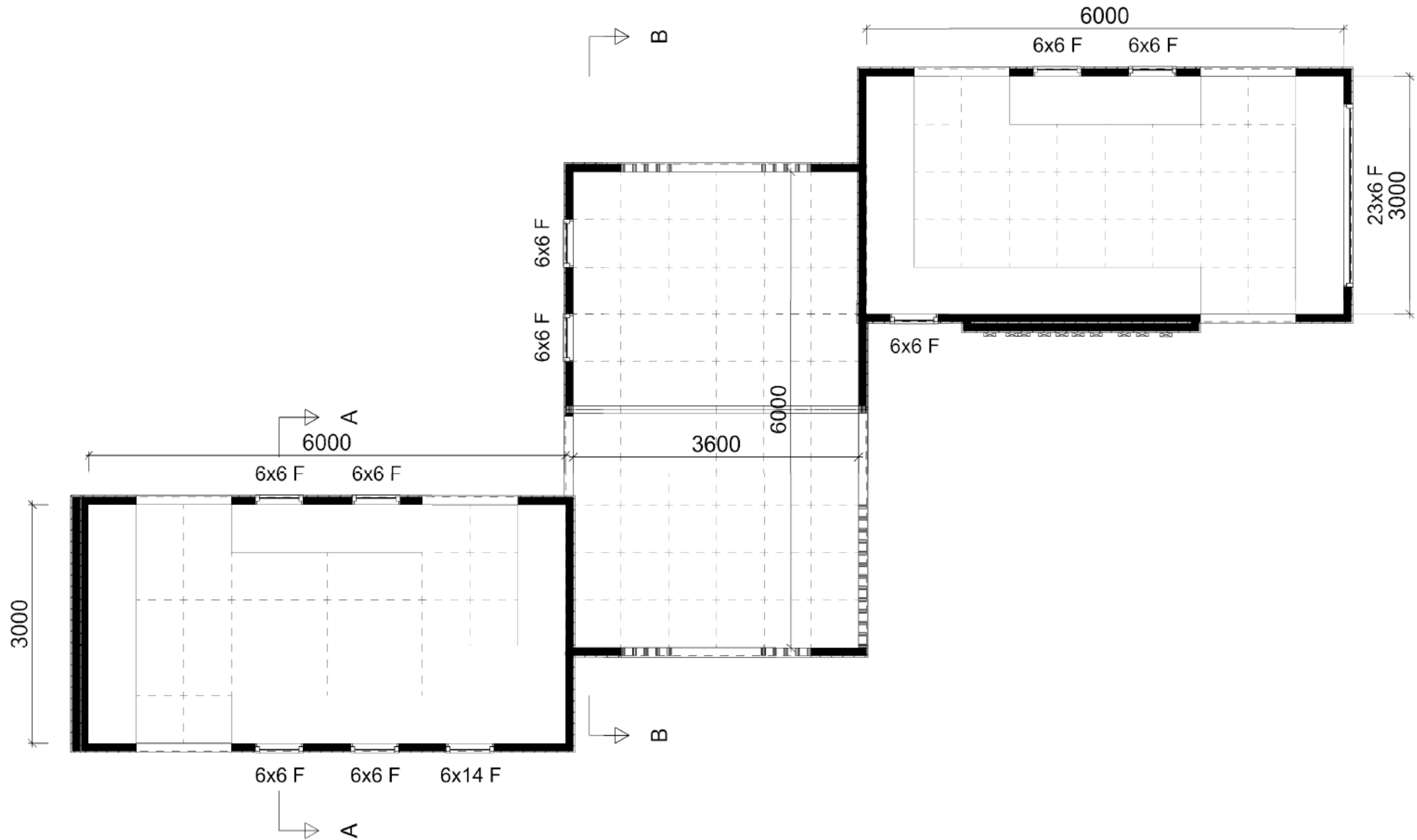

 klimasmart med deg	Tiltakshaver: <u>Overhalla kommune</u>	Uteområde
	Byggeplass: <u>OBUS</u>	Dato: <u>08.01.2020</u>
	Kommune: <u>Overhalla</u>	Tegn: <u>ags</u>
	Gnr: _____ Bnr: _____ Mål: <u>1 : 50</u>	Prosjekt: <u>1814- Uvgerskur</u>
	Plantegning	Tegn.nr: <u>501</u>

© Tegningen kan ikke brukes uten samtykke fra Ark. Blom as

Utebenk med tak

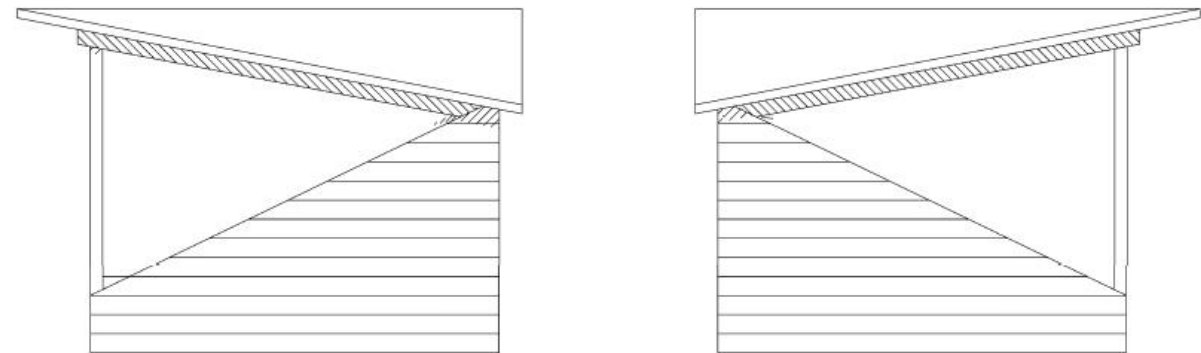
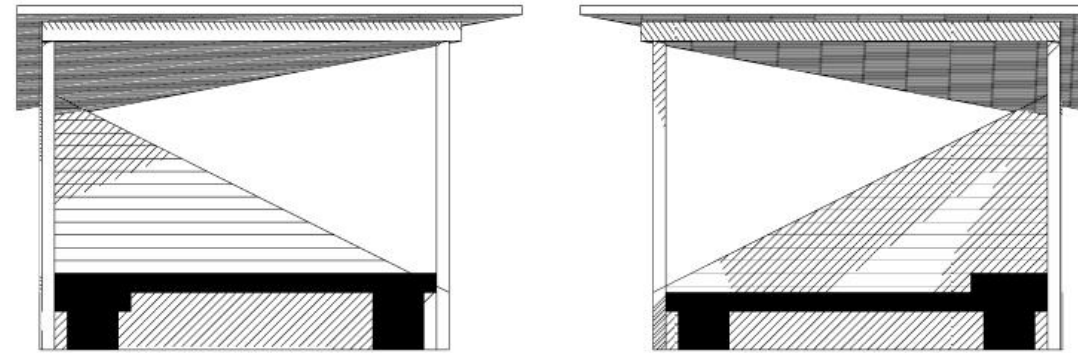
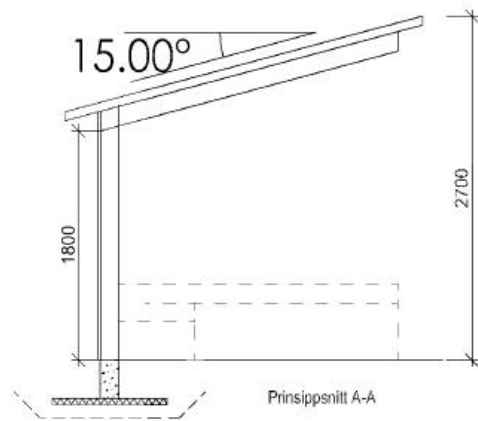
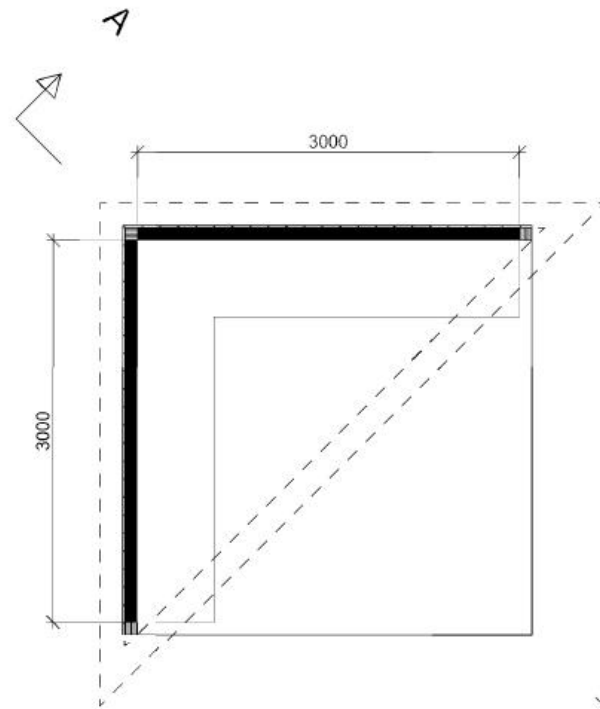

DENNE TEGNINGEN MÅ IKKE BRUKES SOM ARBEIDSTEGNING





klimateknisk
med deg

Tiltakshaver:	Overhalla kommune	Utebenk
Byggeplass:	Uteområde OBUS	Dato: 08.01.2020
Kommune:	Overhalla	Tegn: ags
Gnr:	Bnr:	Mål: 1 : 50
Plan, snitt og fasader		Prosjekt: 1814- Utebenk 1
		Tegn.nr: 501

© Tegningen kan ikke brukes uten samtykke fra Ark. Blom as

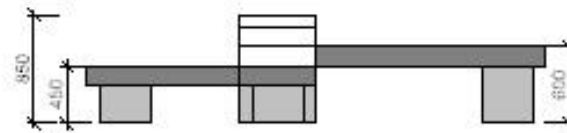
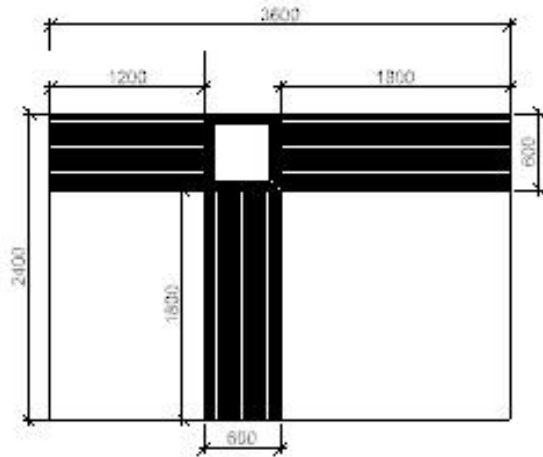
Utebenk med blomsterkasse



	Tilbehør: Overhalla kommune		Utebenk
	Byggeplan: Uteområde OBUS		Dato: 08.01.2020
	Kommune: Overhalla		Tegn: cgs
	Gnr: Bnr: Mål: 1 : 50		Prosjekt: 1814- Utebe
	Plan, snitt og fasader		Tegn nr: 501

DENNE TEIINGEN MÅ IKKE BRUKES SOM ARBEIDSTEIING

Tegningen kan ikke brukes uten samtykke fra Ark. Blom as

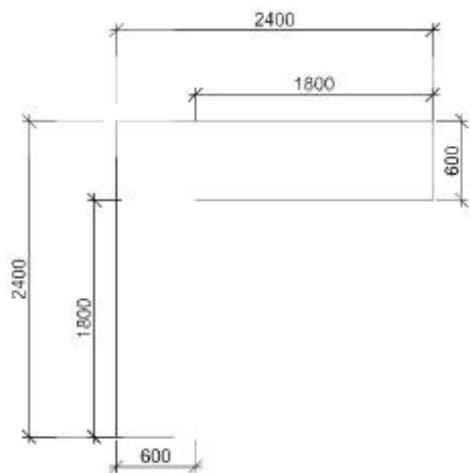

Utebenk



DENNE TEGNINGEN MÅ IKKE BRUKES SOM ARBEIDSTEGNING



Tilakshaver:	Overhalla kommune	Utebenk
Byggeplass:	Uteområde OBUS	Dato: 08.01.2020
Kommune:	Overhalla	Tegn: aqs
Gnr:	Bnr:	Mål: 1 : 50
Plan, snitt og fasader		Prosjekt: 1814- Utebenk
		Tegn.nr: 501
© Tegninger kan ikke brukes uten samtykke fra Ark. Blom as		

Utebenk med rygg vendt i to retninger

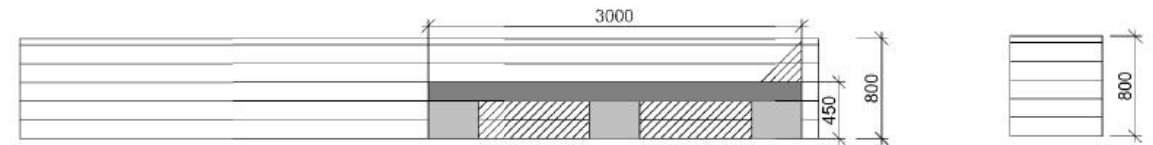
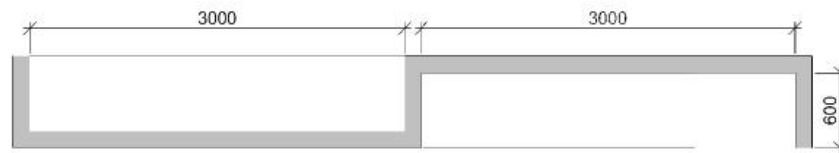

DENNE TEGNINGEN MÅ IKKE BRUKES SOM ARBEIDSTEGNING



Tiltakshaver:	Overhalla kommune	Utebenk
Byggeplass:	Uteområde OBUS	Dato: 08.01.2020
Kommune:	Overhalla	Tegn: ags
Gnr:	Bnr:	Mal: 1 : 50
Plan, snitt og fasader		Prosjekt: 1814-Uteb
		Tegn.nr.: 501
		© Tegningen kan ikke brukes uten samtykke fra Ark. Blom as

Utebenk med rygg vendt i to retninger - stor

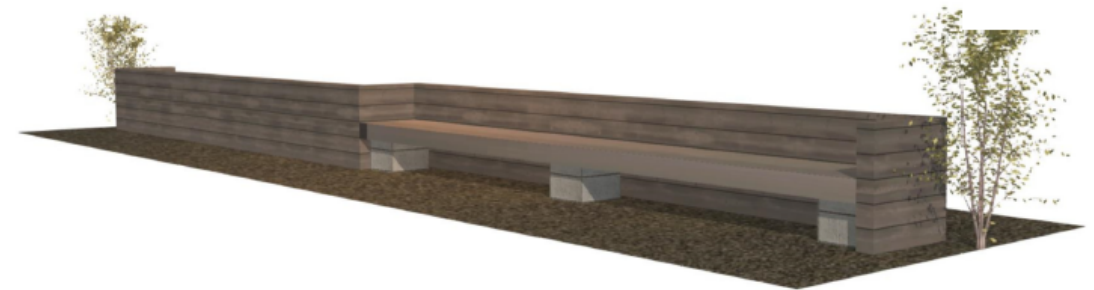
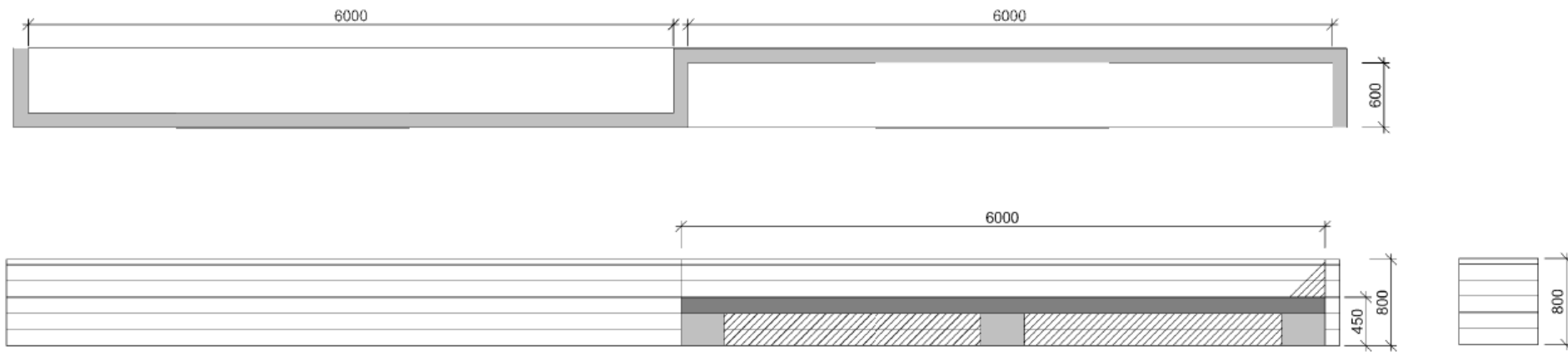

DENNE TEGNINGEN MÅ IKKE BRUKES SOM ARBEIDSTEGNING



klimatektonikk
med deg

Tiltakshaver:	Overhalla kommune	Utebenk
Byggeplass:	Uteområde OBUS	Dato: 08.01.2020
Kommune:	Overhalla	Tegn: cgs
Gnr:	Bnr:	Mål: 1 : 50
Plan, snitt og fasader		Prosjekt: 1814- Utebenk
		Tegn.nr: 501

© Tegningen kan ikke brukes uten samtykke fra Ark. Blom as

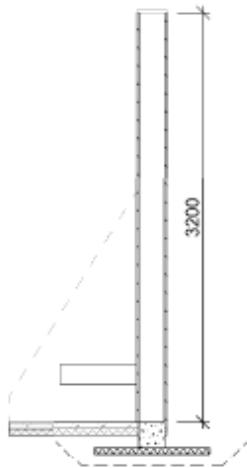
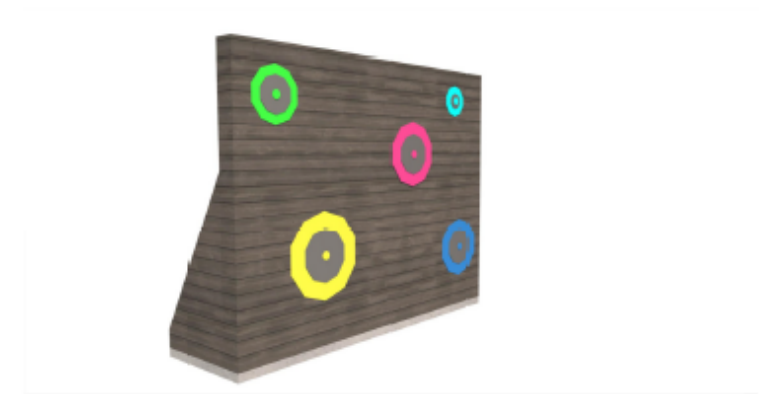
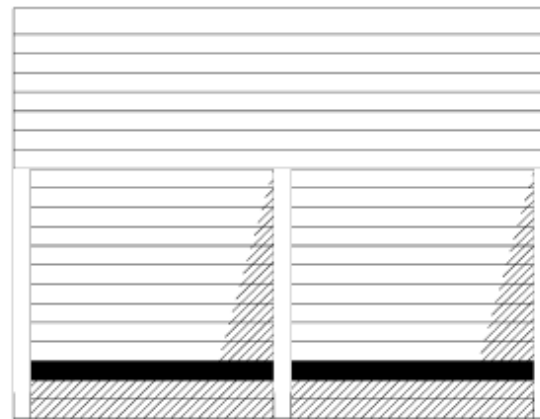
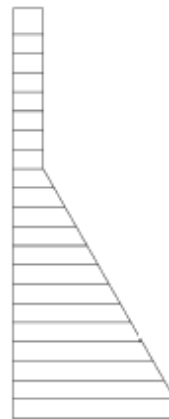
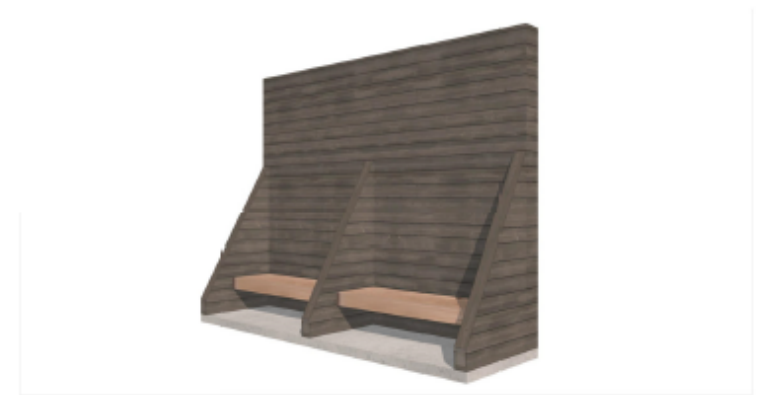
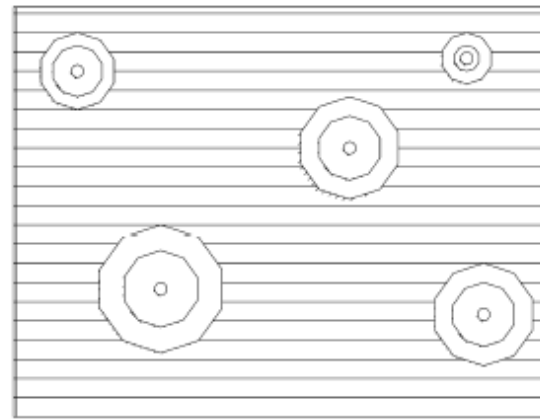
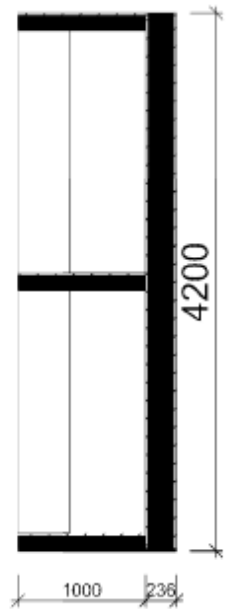

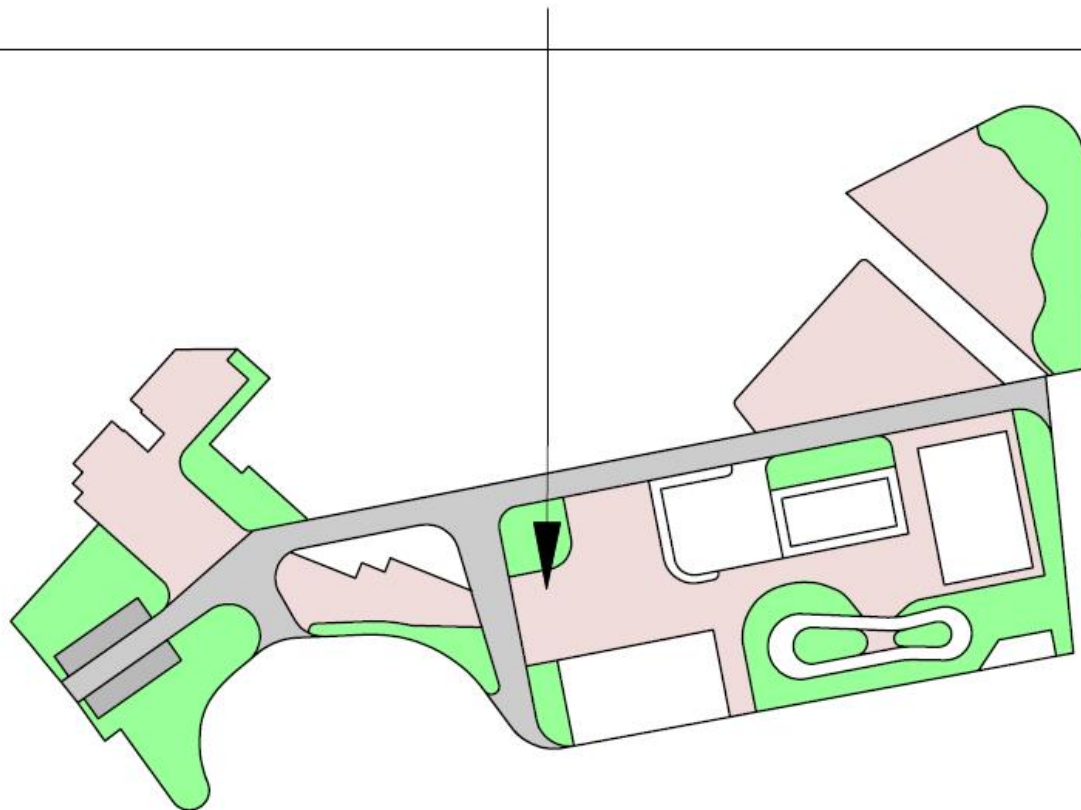
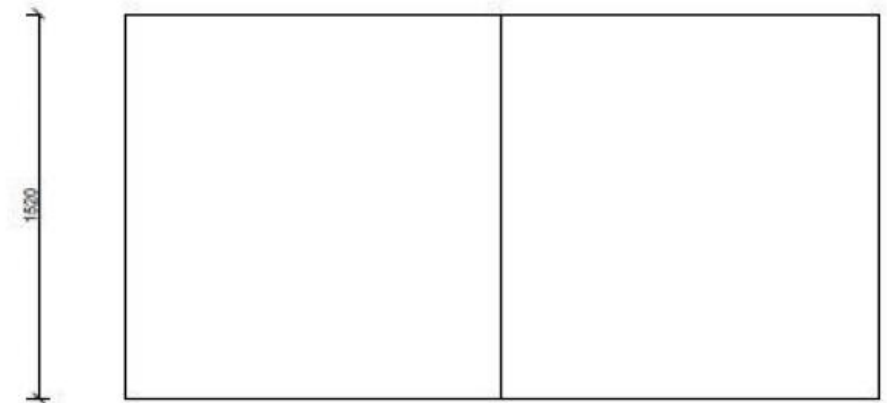
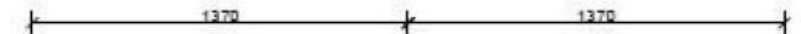
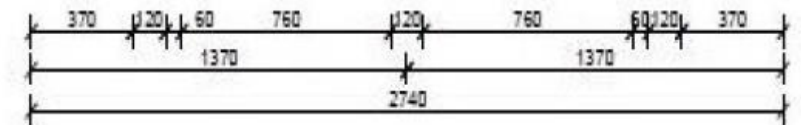
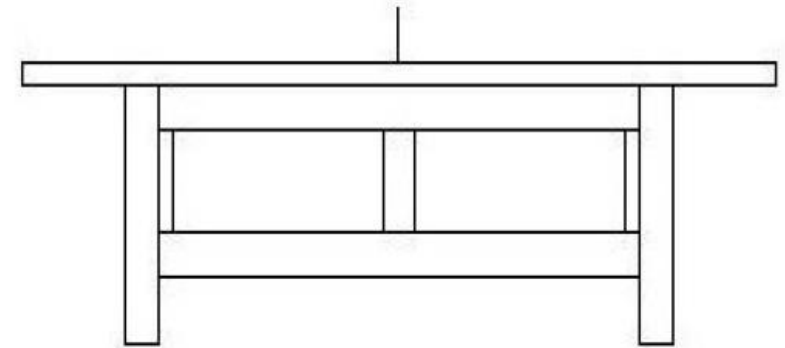
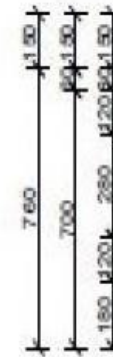

 <small>Klimasmart med deg</small>	Tittelghaver: Overhalla kommune		Ballvegg
	Byggeklasse: OBUS		Date: 08.01.2020
	Kommune: Overhalla		Tegn: ags
	Gnr: _____	Bnr: _____	Mal: 1 : 50
	Plan,snitt og fasade		Prosjekt: 1814- Ballvegg I
			Tegn.nr: 501
DENNE TEGNINGEN MÅ IKKE BRUKES SOM ARBEIDSTEGNING			© Tegningen kan ikke brukes uten samtykke fra Ark. Blom as

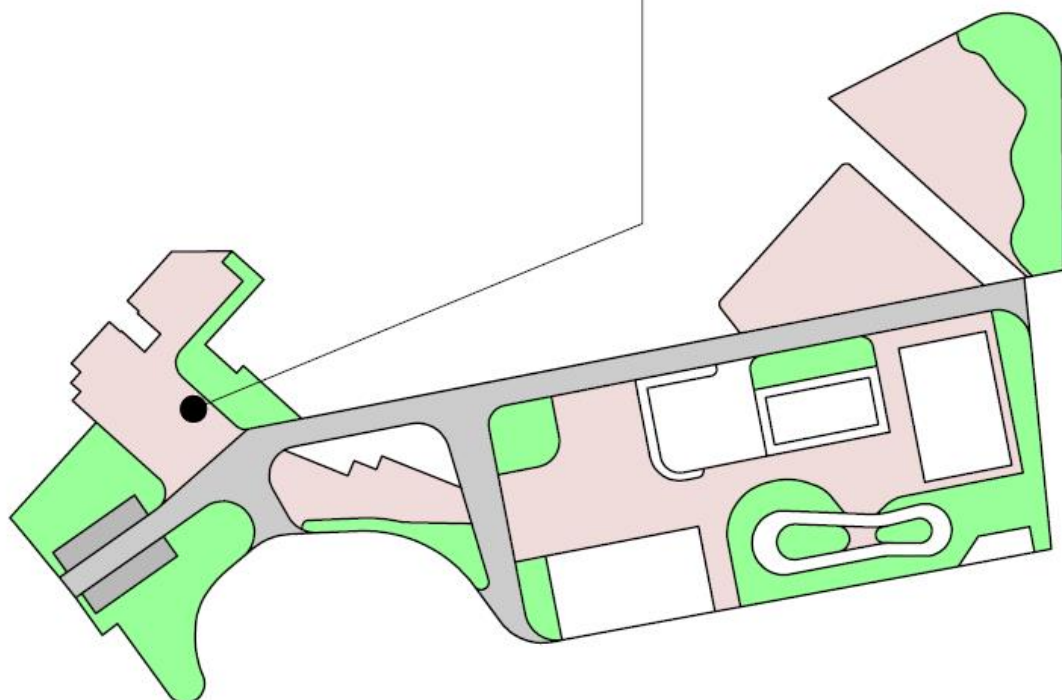

 klimasmart med deg	Tiltakshaver: Overhalla Kommune	Utomhus
	Byggeclass: OBUS	Dato: 08.01.2020
	Kommune: Overhalla Kommune	Tegn: KF
	Gnr: Bnr: Mål: 1 :	Prosjekt: 1814 område
	Bordtennis	Tegn.nr: 520

© Tegningen kan ikke brukes uten samtykke fra Ark. Blom as



 Almasmart med deg	Tiltakshaver:	Overhalla Kommune	Utomhus	
	Byggeklass:	OBUS	Dato: 08.01.2020	
	Kommune:	Overhalla Kommune	Tegn: KF	
	Gnr:	Bnr:	Mål: 1 :	Prosjekt: 1814 område
				Tegn.nr: 522
Store sjakkbrikker			© Tegningen kan ikke brukes uten samtykke fra Ark. Blom as	

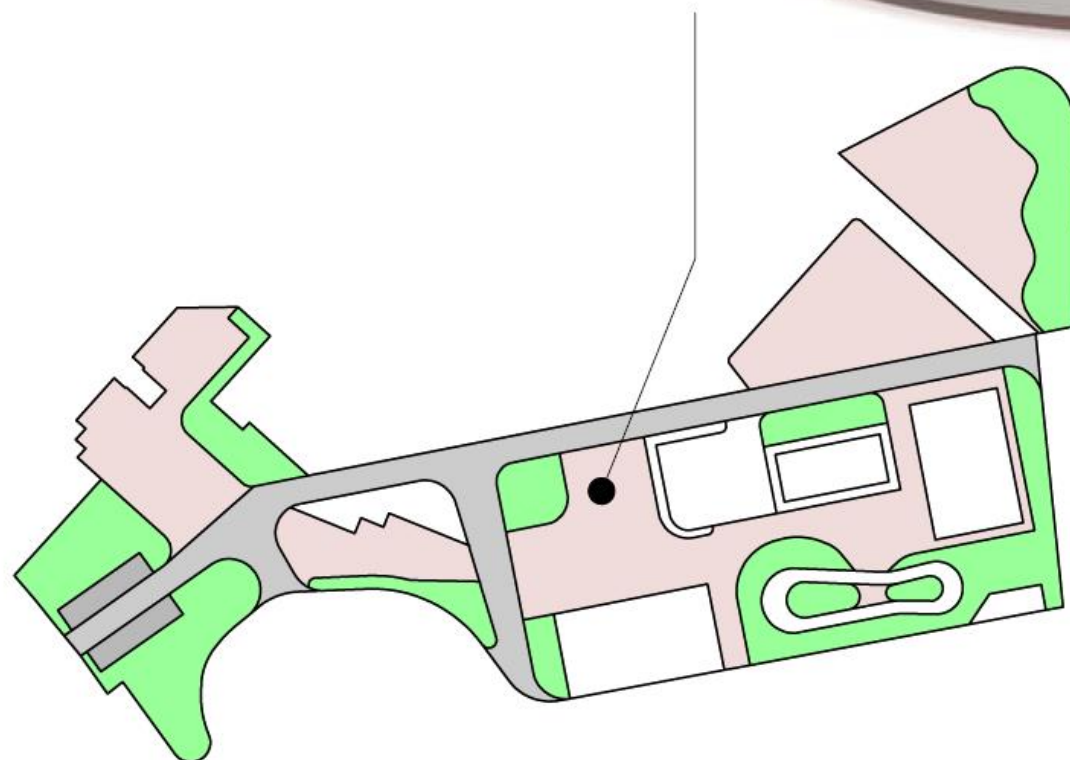
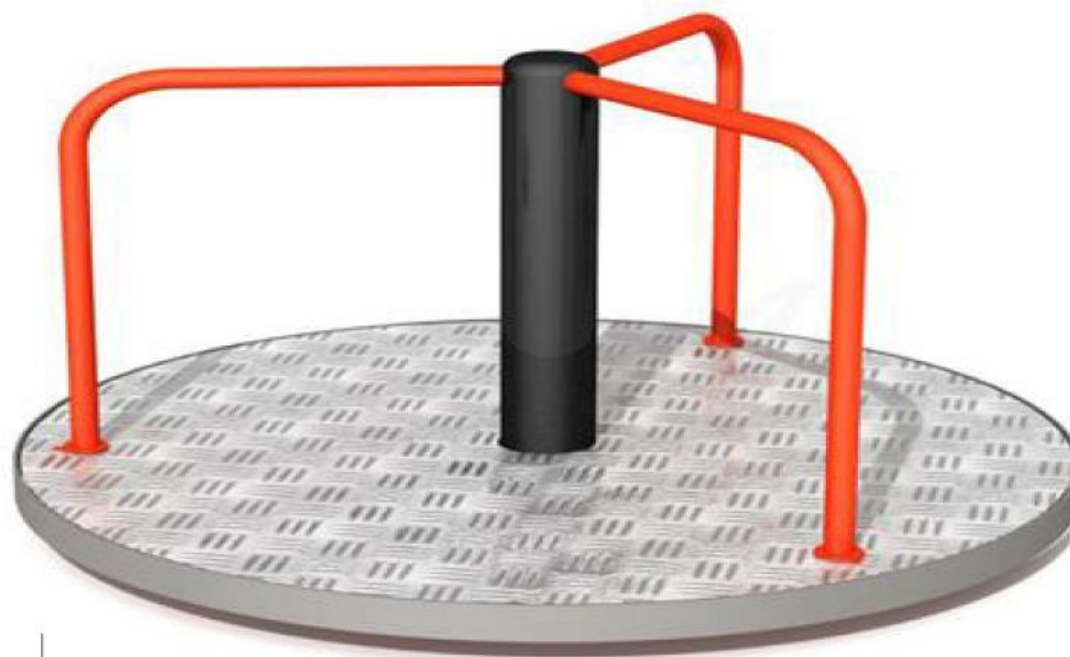

 Arkitektur med deg	Tilakshaver: Overhalla Kommune	Utomhus
	Byggeclass: ØBUS	Dato: 08.01.2020
	Kommune: Overhalla Kommune	Tegn: KF
	Gnr: _____ Bnr: _____ Mål: 1 : _____	Prosjekt: 1814 område
	Karusell	Tegn.nr: 521

© Tegningen kan ikke brukes uten samtykke fra Ark. Blom as

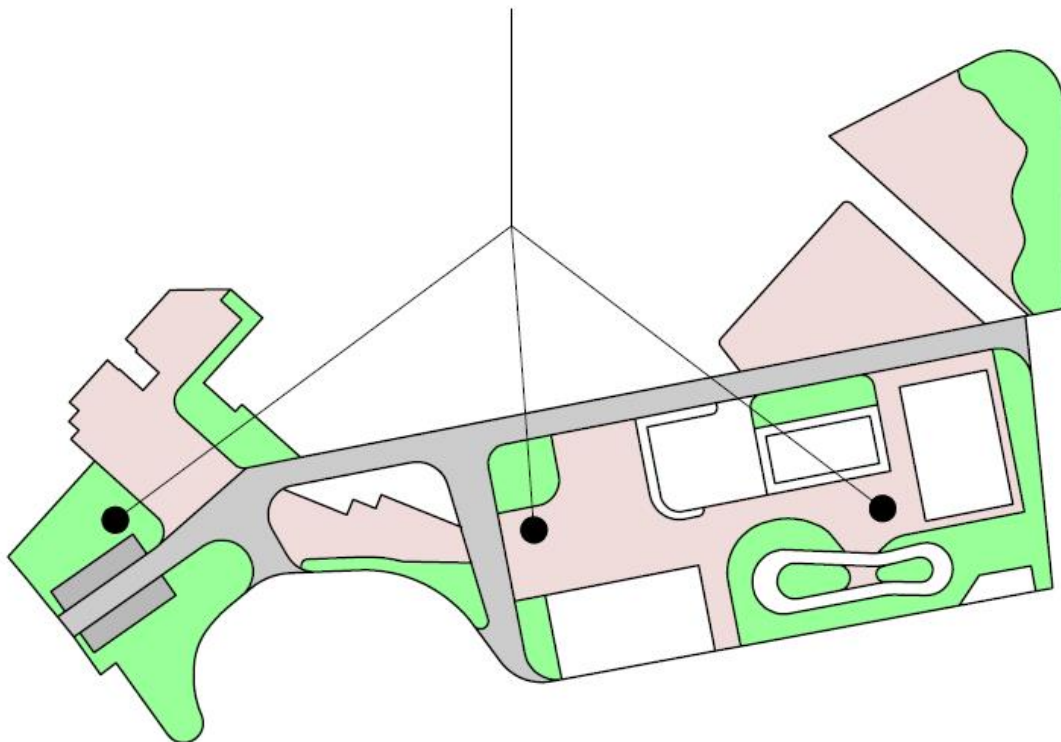

 BLOM arkitekter Klimasmart med deg	Tiltakshaver:	Overhalla Kommune	Utomhus	
	Byggeplass:	ØBUS	Dato: 08.01.2020	
	Kommune:	Overhalla Kommune	Tegn: KF	
	Gnr:	Bnr:	Mål: 1 : 1	Prosjekt: 1814 område
				Tegn.nr: 523
	Huske	© Tegningen kan ikke brukes uten samtykke fra Ark. Blom as		

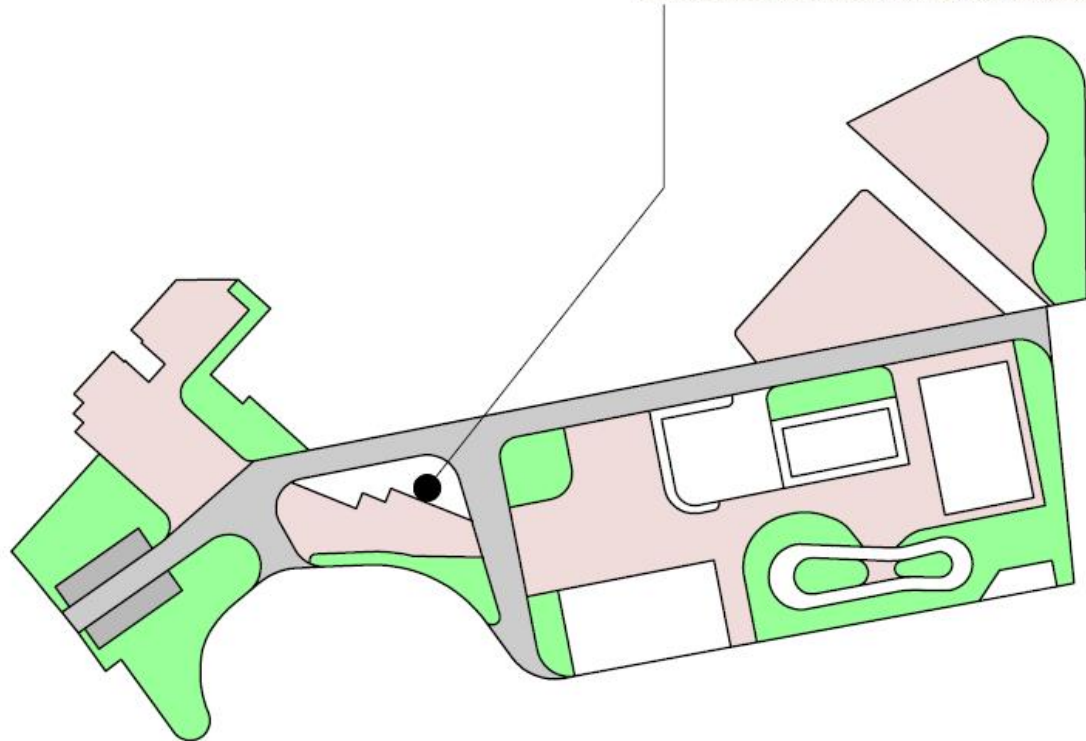

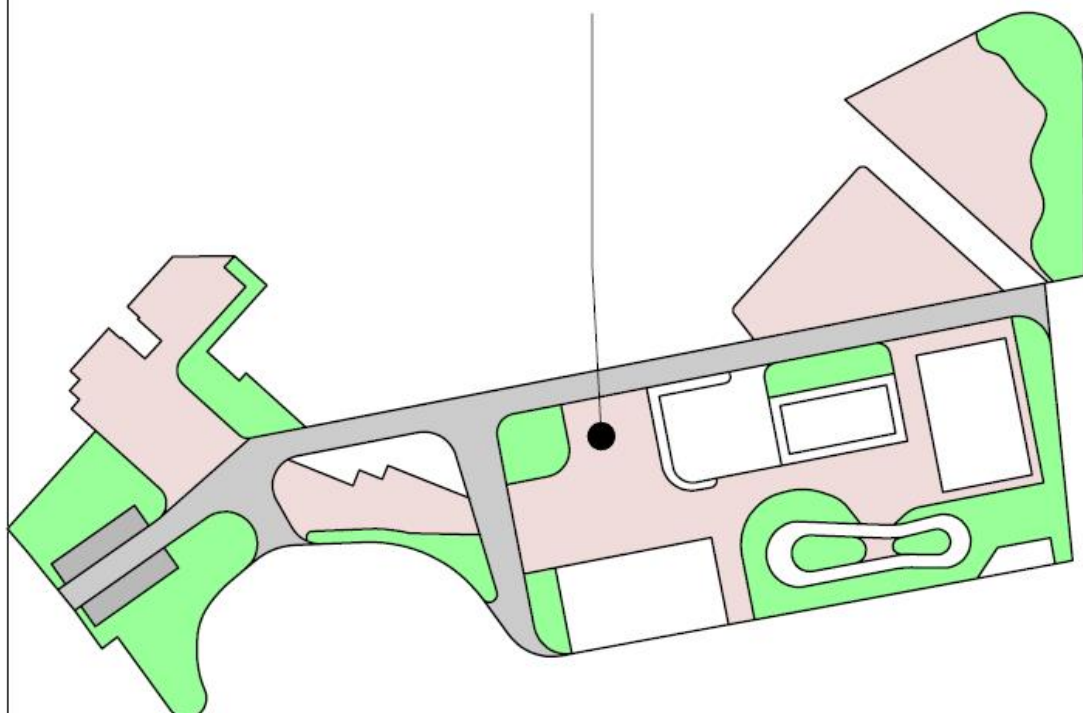
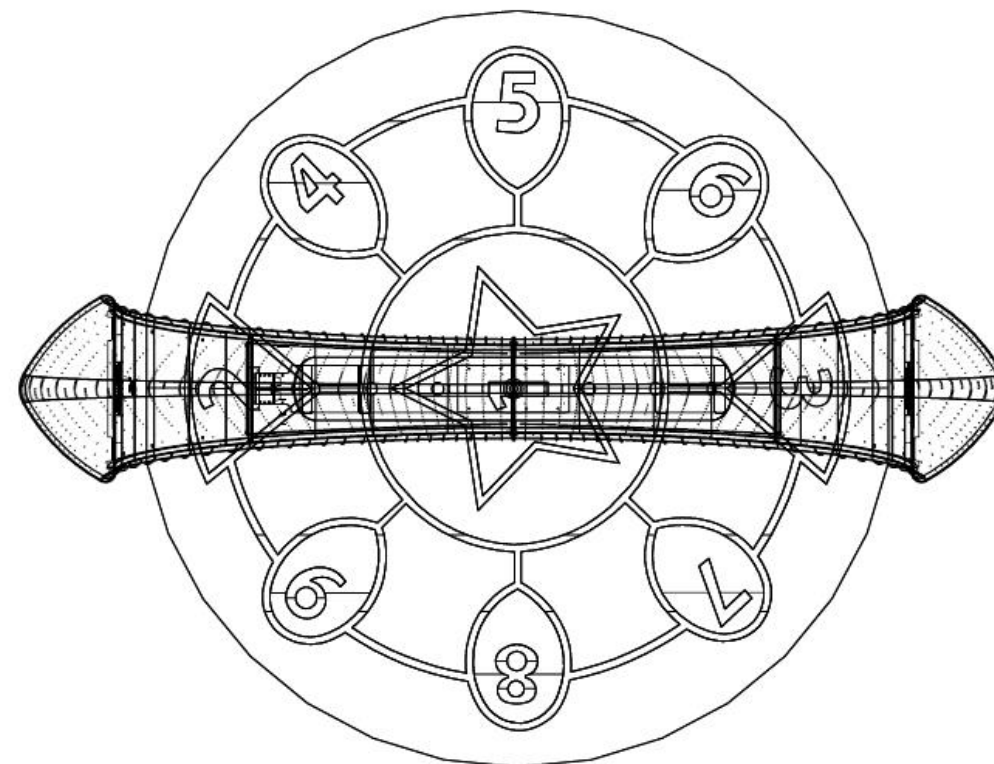

 klimasmart med deg	Tiltakshaver: Overhalla Kommune	Utomhus
	Bvogenlass: ØBUS	Dato: 08.01.2020
	Kommune: Overhalla Kommune	Tegn: KF
	Gnr. _____ Bnr. _____ Mål: 1 : _____	Prosjekt: 1814 område
	Interaktiv - PlayAlive Sport	Tegn.nr: 524
© Tegningen kan ikke brukes uten samtykke fra Ark. Blom as		

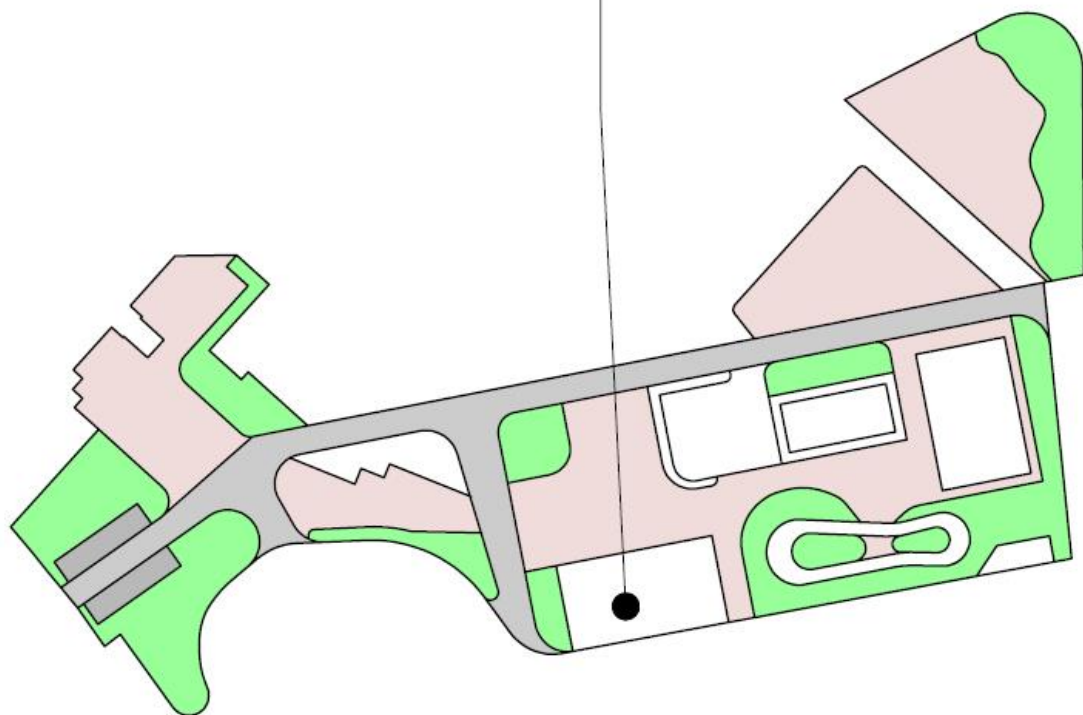
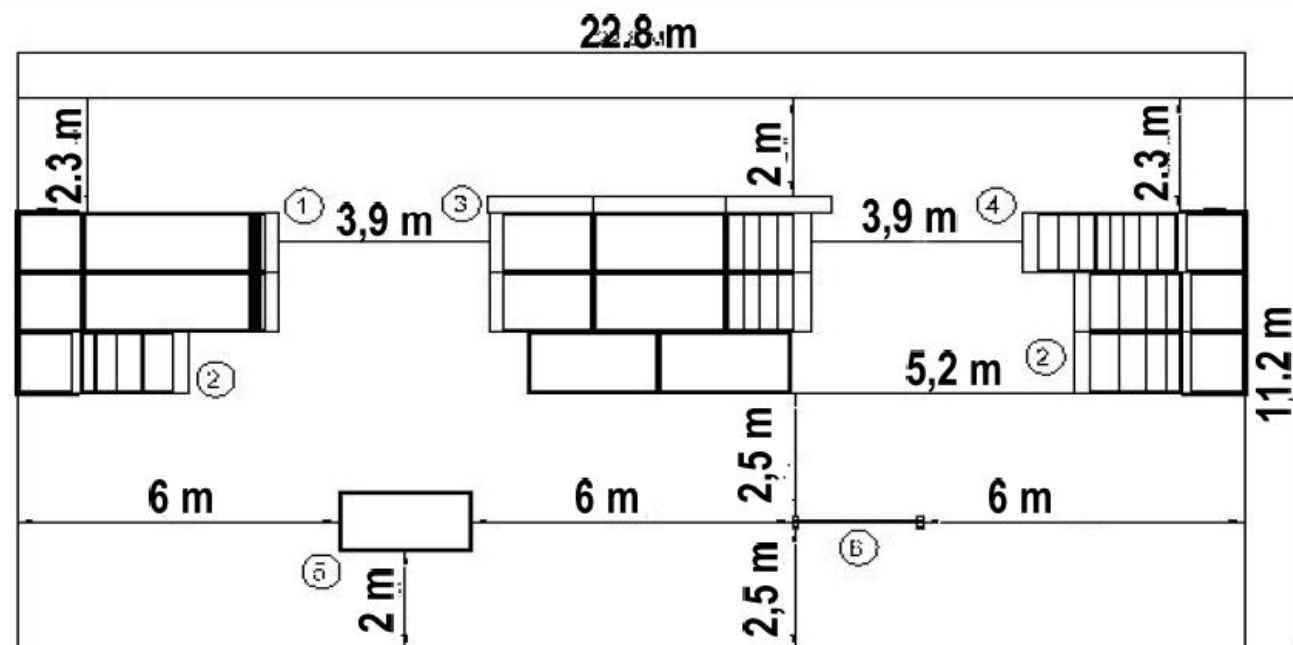
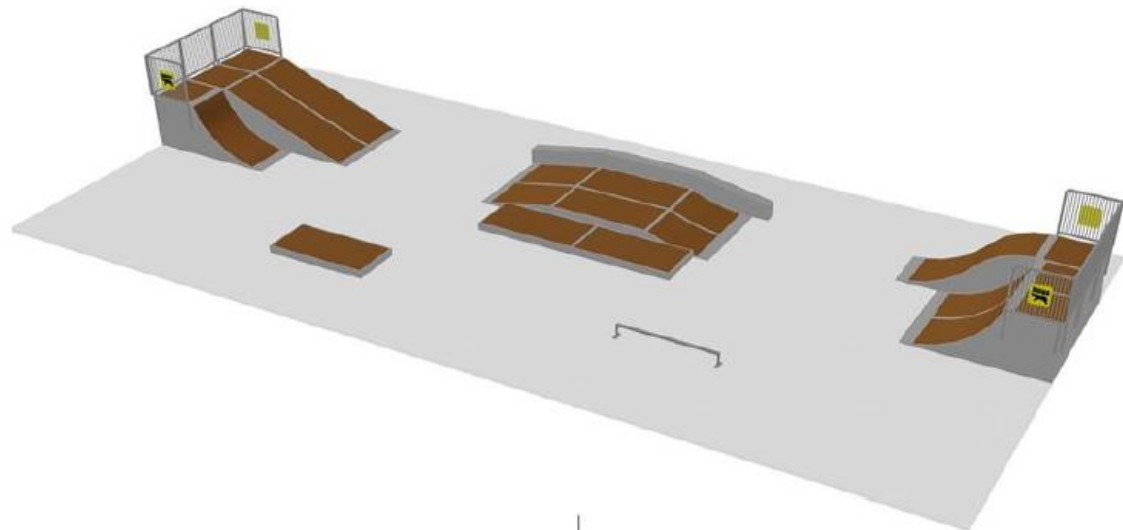

 klima smart med deg	Tiltakshaver: Overhalla Kommune	Utomhus
	Bvonneklass: OBUS	Dato: 08.01.2020
	Kommune: Overhalla Kommune	Tegn: KF
	Gnr: Bnr: Mål: 1 :	Prosjekt: 1814 område
	Interaktiv - Sona	Tegn.nr: 525

© Tegningen kan ikke brukes uten samtykke fra Ark. Blom as



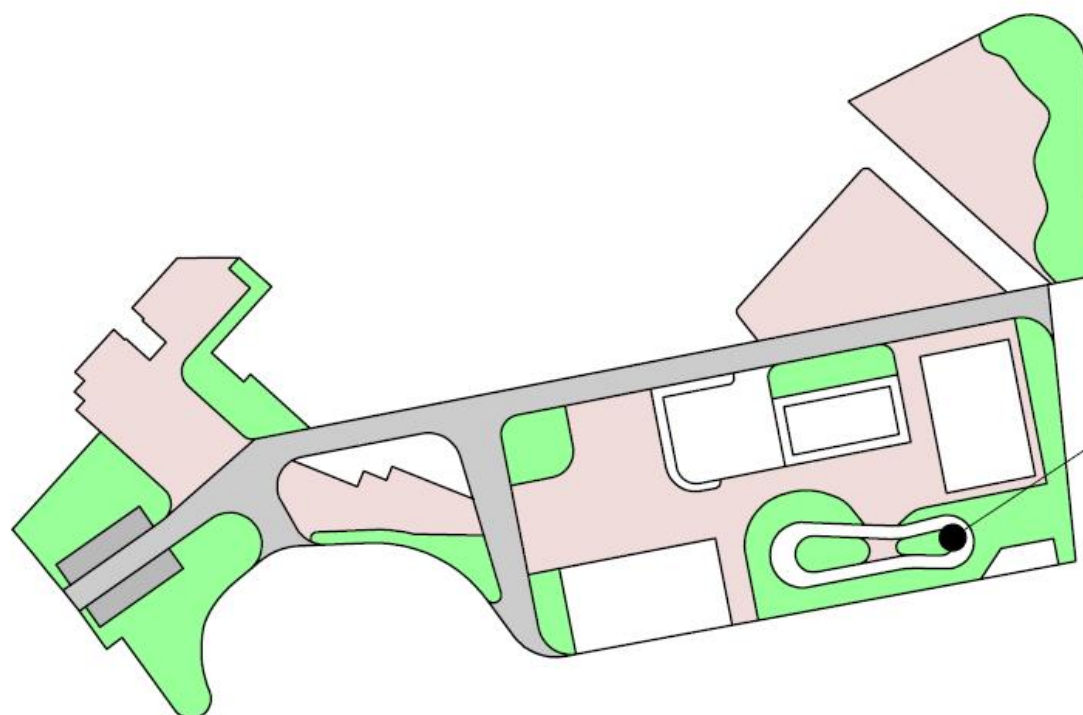

 klimasmart med deg	Tiltakshaver: Overhalla Kommune	Utomhus
	Bvognklass: ØBUS	Dato: 08.01.2020
	Kommune: Overhalla Kommune	Tegn: KF
	Gnr: Bnr: Mål: 1 :	Prosjekt: 1814 område
	Skatepark	Tegn.nr: 526

© Tegningen kan ikke brukes uten samtykke fra Ark. Blom as



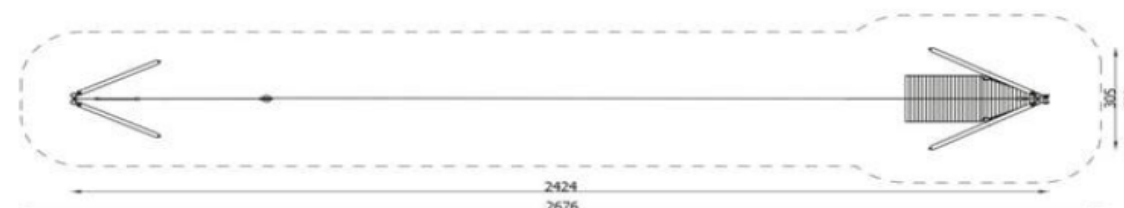
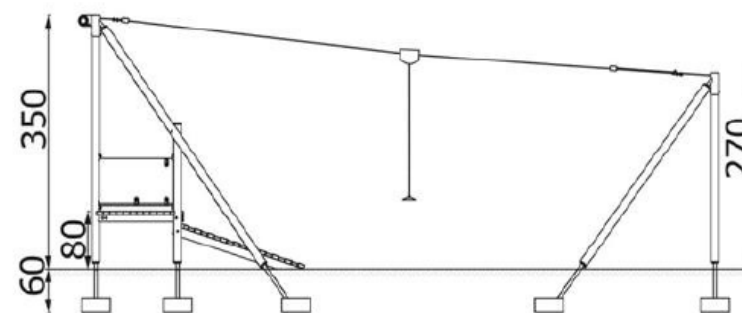
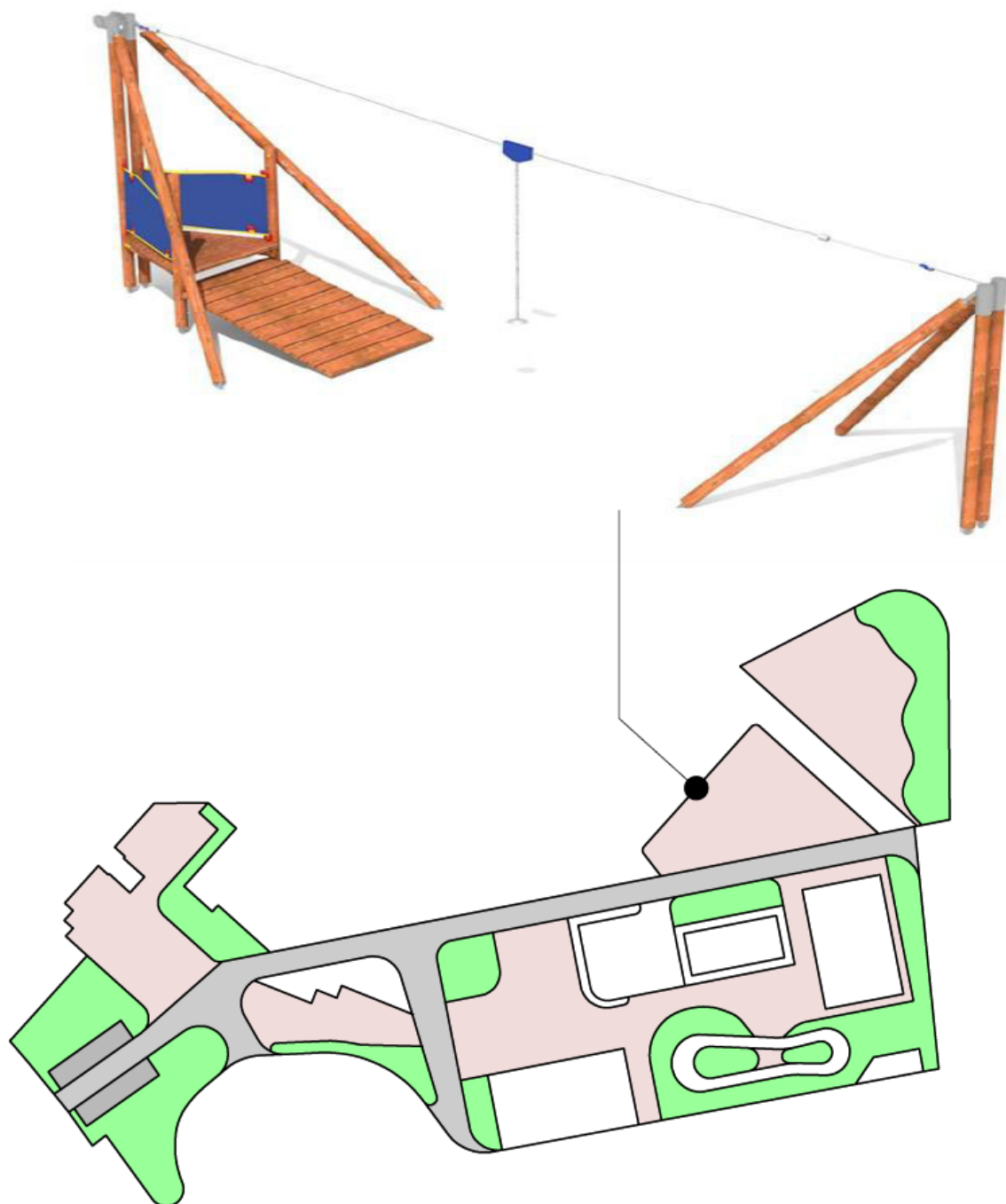

 klimasmart med deg	Tiltakshaver: Overhalla Kommune	Utomhus
	Byggeplass: OBUS	Dato: 08.01.2020
	Kommune: Overhalla Kommune	Tegn: KF
	Ønr: _____	Prosjekt: 1814 område
	Bnr: _____ Mål: 1 : _____	Tegn.nr: 527
Pumptrack		© Tegningen kan ikke brukes uten samtykke fra Ark. Blom as

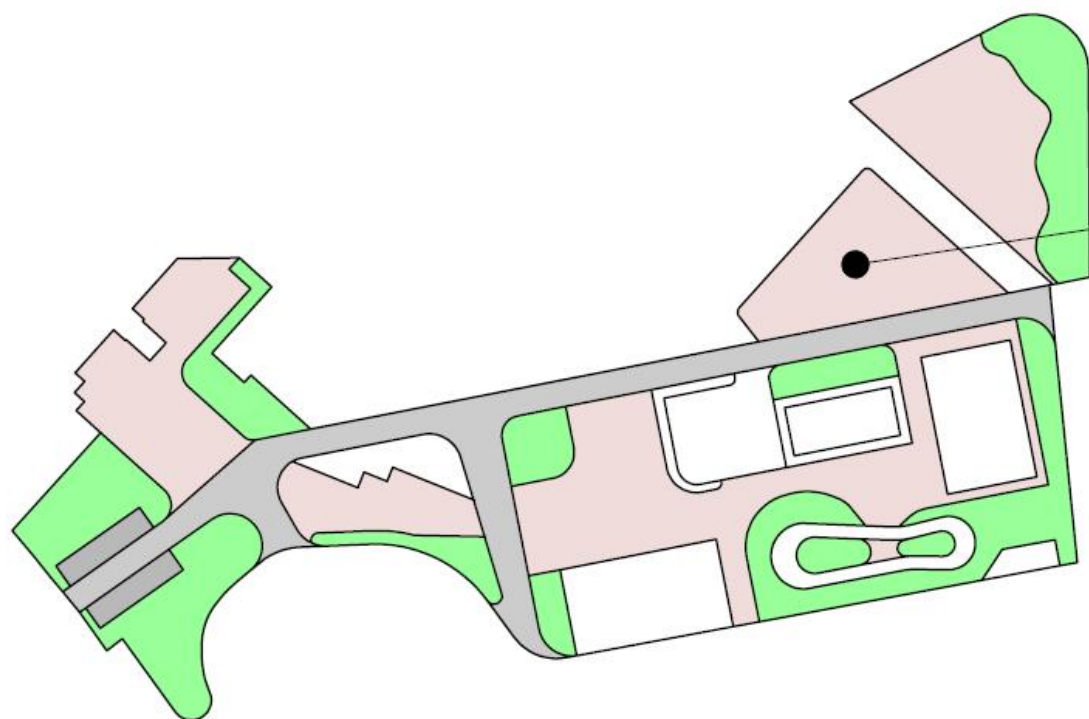

 <small>klimalsmart med deg</small>	Tiltakshaver: Overhalla Kommune	Utomhus
	Byggeplass: OBUS	Dato: 08.01.2020
	Kommune: Overhalla Kommune	Tegn: KF
	Gnr: Bnr: Mål: 1 :	Prosjekt: 1814 område
	Taubane	Tegn.nr: 528

© Tegningen kan ikke brukes uten samtykke fra Ark. Blom as



 Klimasmart med deg	Tiltakshaver: Overhalla Kommune	Utomhus
	Byggerlass: OBUS	Dato: 08.01.2020
	Kommune: Overhalla Kommune	Tegn: KF
	Gnr: Buldrestein	Prosjekt: 1814 område
	Bnr: Mål: 1 :	Tegn.nr: 529
© Tegningen kan ikke brukes uten samtykke fra Ark. Blom as		

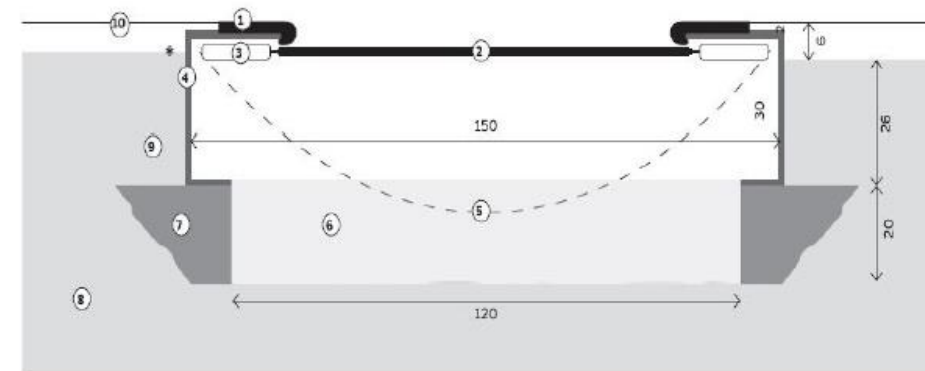

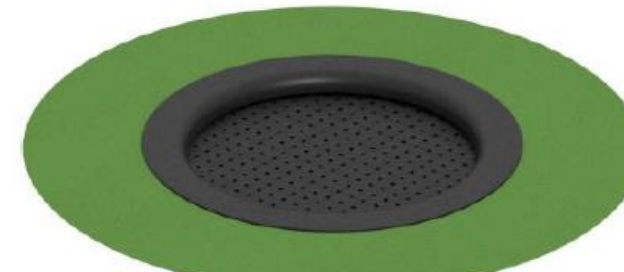

Illustrasjonen over viser tversnitt av prinsipp for montering for Loop 1.0
 Mål stålkasse (4) 1.0 er 150 x 150 x 30 cm
 Mål utsparringsramme for forskaling 120 x 120 x 20 cm

- 1 Gummiring for optimal overgang og sikkerhet
- 2 Hoppduk
- 3 Fjærer
- 4 Stålkasse
- 5 Bevegelse duk/fjærer
- 6 Utsparingsramme for forskaling (det støpes på utsiden av denne forskalingen)
- 7 Betong
- 8 Drenerert sams masse
- 9 Drenerert sams masse med ekstra stor stein for å unngå setning *
- 10 Helstøpt gummidেকে

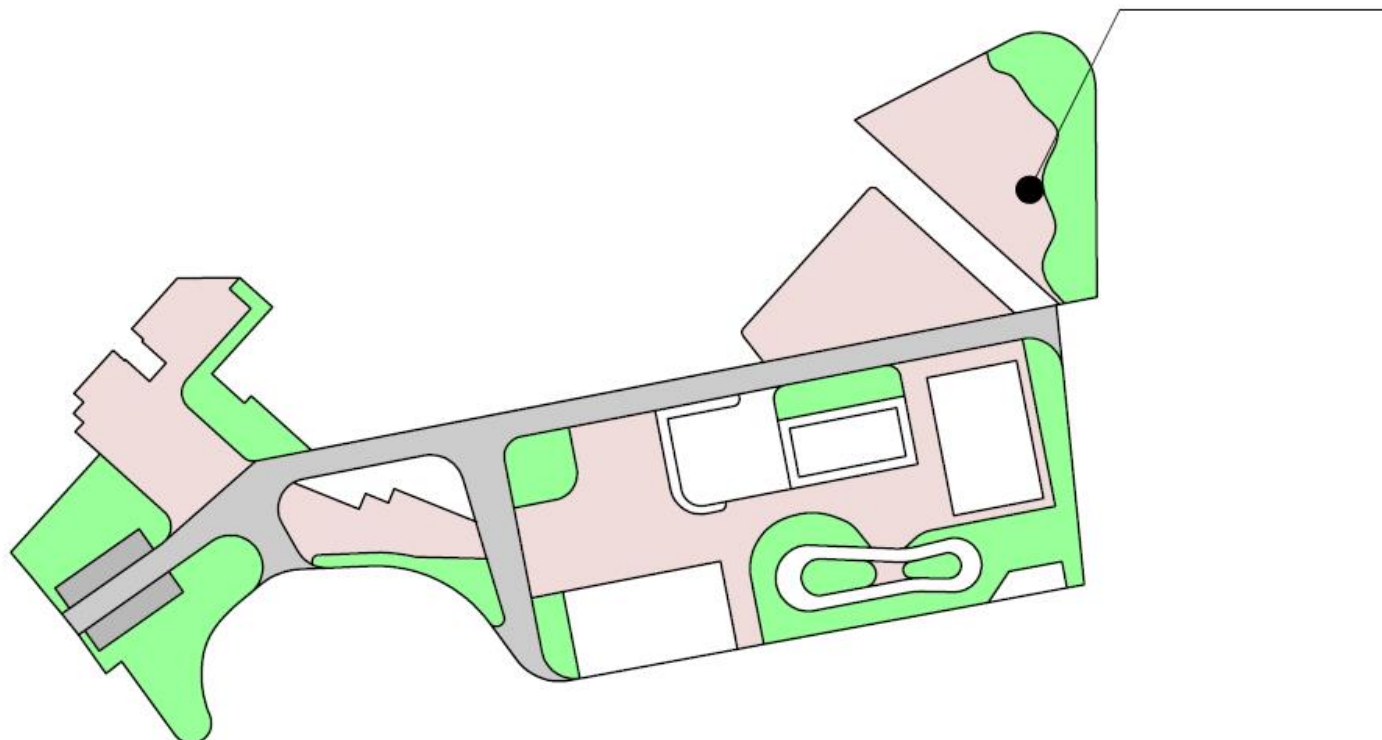

Kidstramp Loop 1.0 med Playpro gummiring montert i helstøpt gummidেকে.



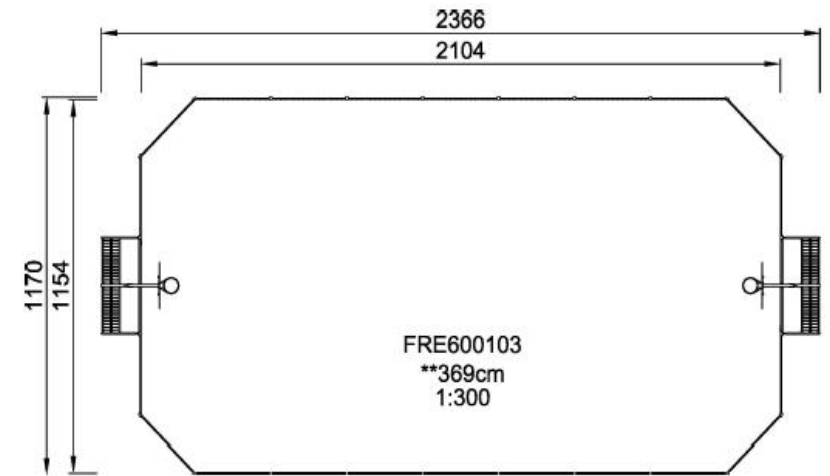

 Klimasmart med deg	Tiltakshaver: Overhalla Kommune	Utomhus
	Bvgerklass: OBUS	Dato: 08.01.2020
	Kommune: Overhalla Kommune	Tegn: KF
	Gnr: _____ Bnr: _____ Mål: 1 :	Prosjekt: 1814 område
	Trampoline	Tegn.nr: 530

© Tegningen kan ikke brukes uten samtykke fra Ark. Blom as

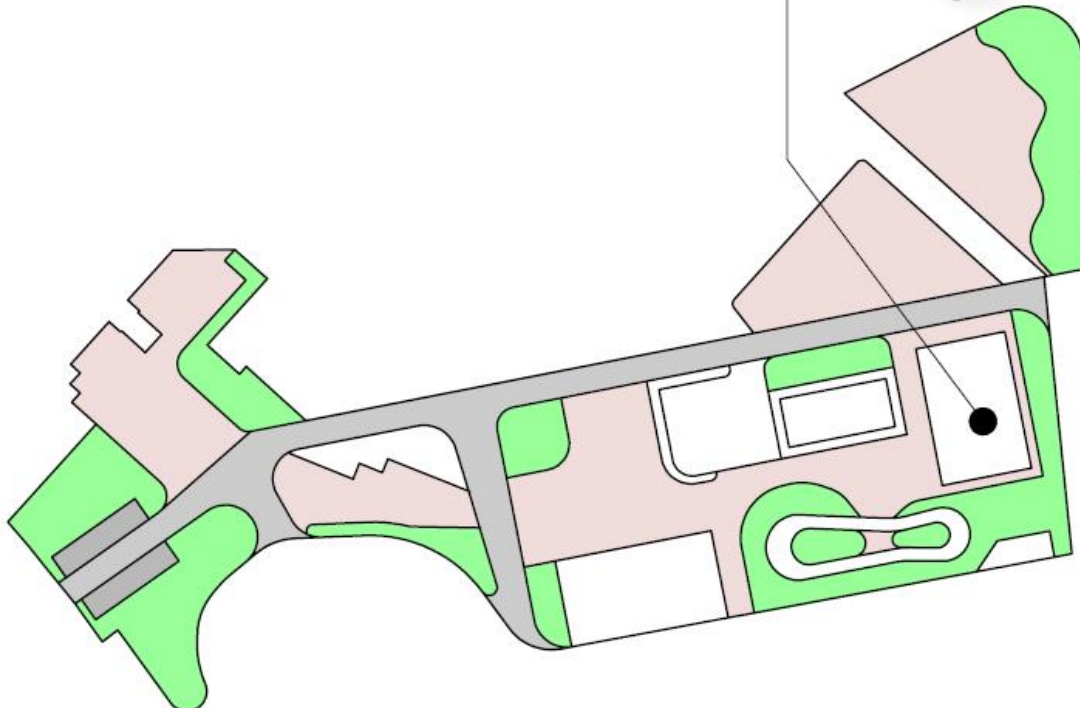

FRE600103
1:300



 klimasmart med deg	Tilakshaver: Overhalla Kommune	Utomhus
	Byggeplass: OBUS	Dato: 08.01.2020
	Kommune: Overhalla Kommune	Tegn: KF
	Gnr: _____ Bnr: _____ Mål: 1 : _____	Prosjekt: 1814 område
	Ballbinge	Tegn.nr: 531

© Tegningen kan ikke brukes uten samtykke fra Ark. Blom as